

ASSEMBLY INSTRUCTIONS

Hanging Hammock Flying Saucer with Bird & Bug Net



FlowerHouse[®]

www.flowerhouses.com (810) 686-8252

INTRODUCTION

Thank you for purchasing the Hanging Hammock Flying Saucer with Bird & Bug Net! We have designed this hammock for maximum comfort and safety. Please read this document carefully when assembling (you are ultimately responsible for your safety).

FEATURES

Single-point Hanger
Strong Straps
Comfortable Swaying Saucer Hammock
Two drink holders
Bug Net
Bird Net

SPECIFICATIONS

Assembled Height = 6ft. (1.8m.)
Assembled Width = 7ft. (2.13m.)
Weight = 24lbs. (10.8kg.)

WARNING

Follow these warnings to ensure your safety while using this hammock:

- This product is NOT a trampoline or a toy – the hammock is intended for adult resting.
- Do not allow more than two adults to sit in the saucer (weight limit is 400lbs.).
- Be sure to install the hammock on a structure that can support your weight.
- Never stand on the hammock and do not climb or hang from the saucer.
- Stay within the saucer and never spin the saucer when using the hammock.
- Do not use the hammock in high winds.
- Do not exit the saucer unless BOTH feet are planted firmly on the ground.
- If any damage or fraying is found during inspection, immediately remove from service.
- Do not leave in the sun and weather for prolonged periods (exposure can damage fabric).
- Never store any hazardous materials inside the hammock.
- Do not position the hammock close to a camp fire or open water.

PARTS LIST

Be sure to check that all parts of the chair have been shipped below:

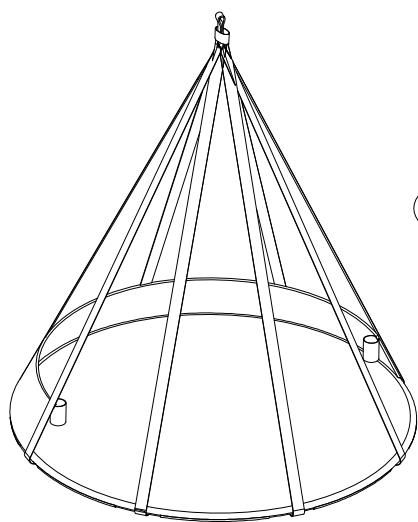

Saucer (1)

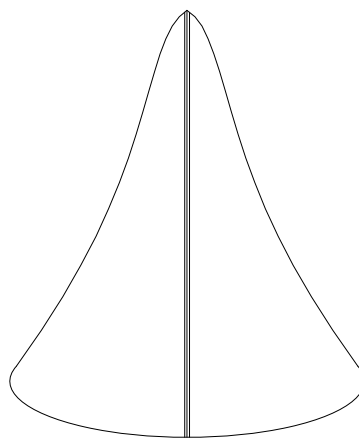

Camping
Cover (1)

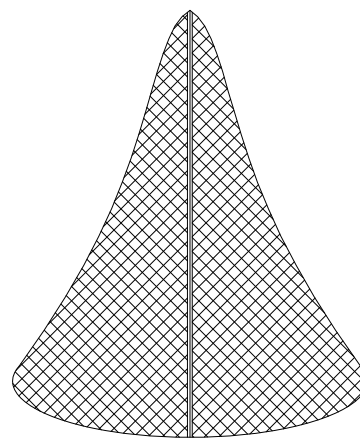

Bug Net (1)



Carabiner (1)

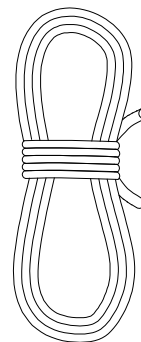

Rope (1)

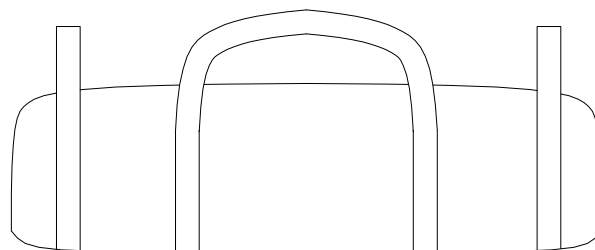

Carry Bag (1)

ASSEMBLY (cont.)

1

Remove any end caps on SAUCER POLES and slide them into sleeves on bottom side of SAUCER.

Saucer Pole

Bottom of Saucer

Straps

Sleeve

2

Pull STRAPS aside and join SAUCER POLES

Strap

BE SURE STRAPS ARE OUTSIDE THE SAUCER POLES

Strap

Strap

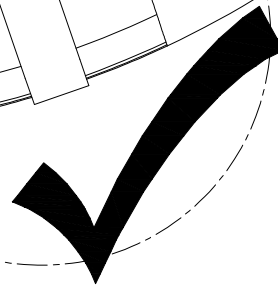
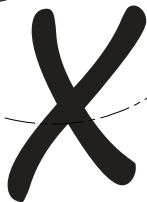

ASSEMBLY (cont.)

3

Choose an overhead support that can withstand 5,000lbs of weight. Tie each end of the rope into a strong knot (similar to the one below).

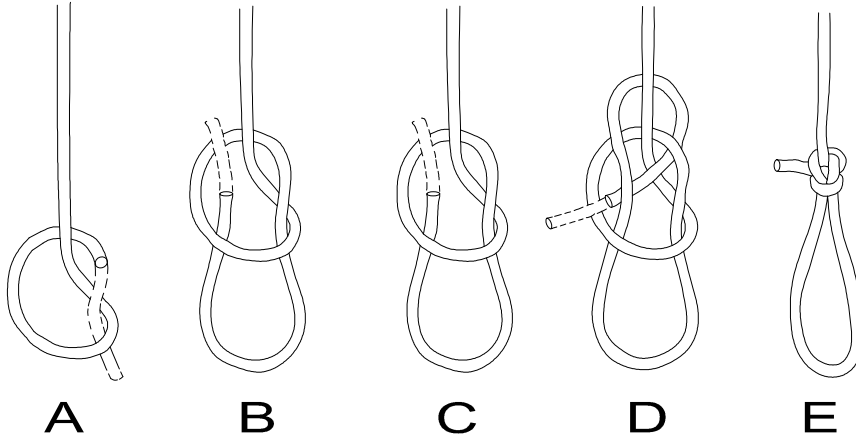

4

Install CARABINEER onto ROPE and BLUE LOOP on SAUCER.

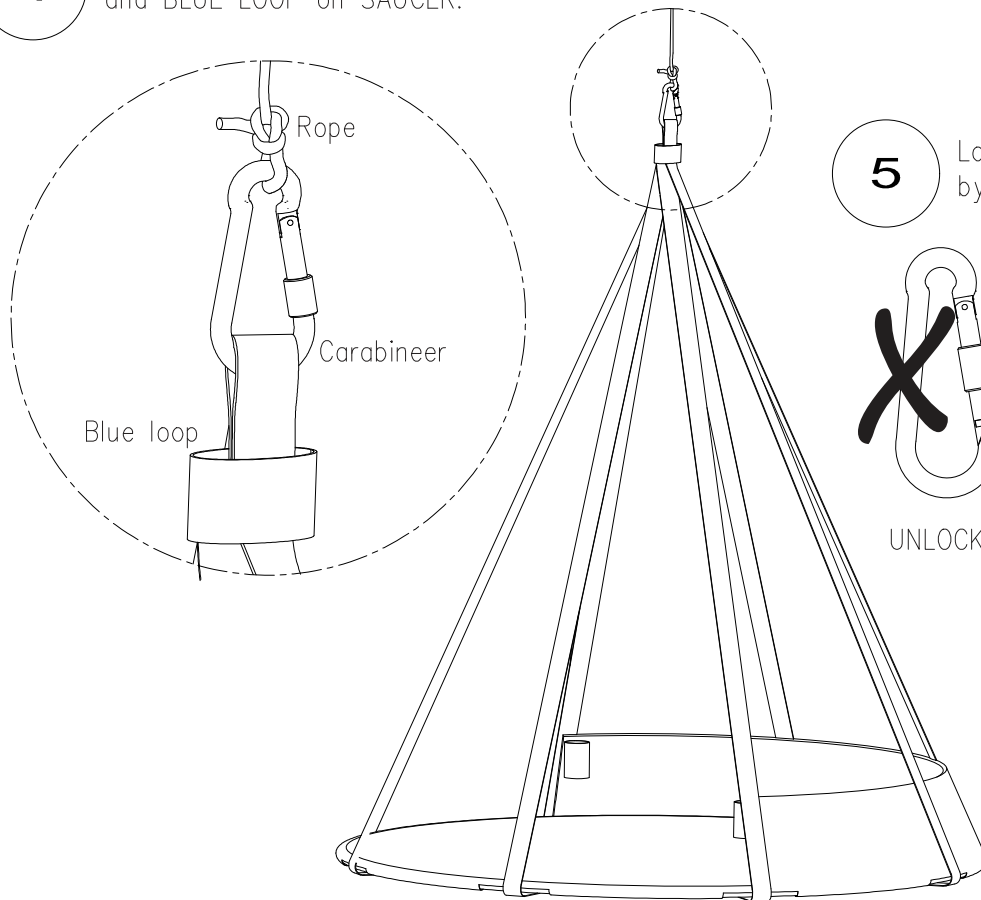

5

Lock CARABINEER gate by twisting barrel.

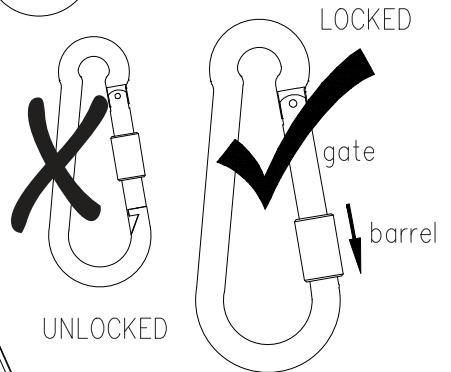

ASSEMBLY (cont.)

- 6** Attach CAMPING COVER by wrapping around SAUCER, feed blue strap through LOOP, closing zipper, and tightening draw strings.

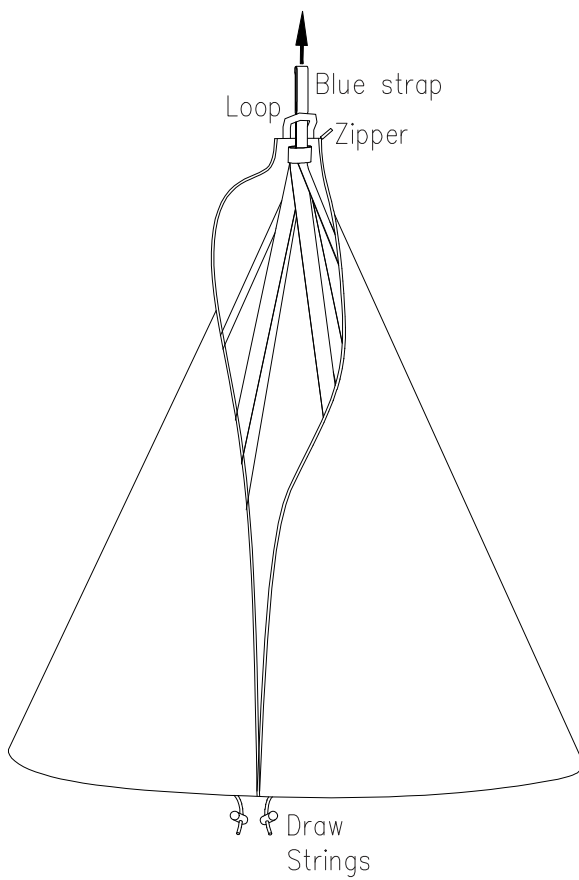

- 7** Attach BUG NET by wrapping around SAUCER, velcro flap over blue strap, closing zipper, and tightening draw string.

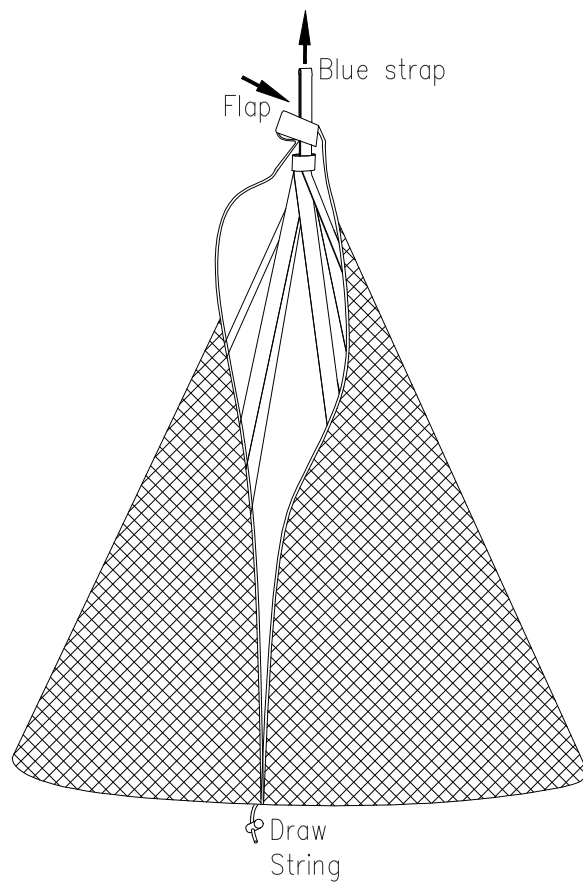

DISCLAIMER

This Manual relates solely and exclusively to the FlowerHouse Chairs and Hammocks including but not limited to the operation thereof. Failure to adhere to this manual or to properly focus on the recommended operation can result in death, serious injury and property damage. Always operate the FlowerHouse products in a safe manner and in full compliance with this manual. FlowerHouse is not liable for any injuries or damages to any operators, property or bystanders incurred as a result of using the FlowerHouse products by its customers. FlowerHouse also cannot be held liable for any and all errors in this manual or for any incidental or consequential damages that result for the use of the material presented in this manual. This manual contains proprietary information belonging solely and exclusively to FlowerHouse. All rights are reserved. No part of this manual may be photocopied, reproduced or translated to another language without the written consent of FlowerHouse. If this disclaimer is unacceptable, please return the unused product within 10 days of purchase (along with proof of purchase) for a full refund to the address below.

W A R R A N T Y C A R D

Mail return within 14 days of purchase with copy of dated register receipt to activate warranty. Please make a copy of this card for your records and mail to:

FLOWERHOUSE
P.O. BOX 595
CLIO, MI 48420-0595

PRODUCT MODEL NO. _____

NAME: _____

DATE OF PURCHASE: _____

ADDRESS: _____

EMAIL: _____

SIGNATURE: _____ DATE: _____

(my signature acknowledges that I have read, fully understand, and accept this limited warranty agreement)