

# INSTRUCTION MANUAL

## Bonfireball



**Bonfireball™**  
www.Bonfireball.com Patent Pending

P.O. Box 595 Clio, MI 48420

(810) 686-8252

Made in China, Designed in Hawaii, USA

Exclusively for World Wide Creations

Patents Pending

## Introduction

Thank you for purchasing the Bonfireball. This product is made of high quality materials and is intended to last. **Read all safety warnings, instructions, and illustrations provided in this manual.**

## Safety Language

This instruction manual uses the following safety alert symbols and words to alert you to hazardous situations and your risk of personal injury or property damage. **Warning:** Indicates a potential injury or damage to property. **Hazardous:** could result in death or serious injury.

## Product Use

Your product is designed for outdoor use **ONLY**.

**DO NOT** use under wet conditions or in presence of flammable liquids or gases.

**DO NOT** let children come into contact with the product.

Supervision is required when inexperienced operators use this product.

Locate the product at least **30-feet away** from any structure on firm, level, bare ground.

Never burn anything other than wood inside the Bonfireball.

**NEVER** use the Bonfireball without the base installed.

## Specifications

Model: Bonfireball

Diameter: Varies

Material: Stainless Steel

## Important Safety Instructions

### ▲ WARNING: RISK OF UNSAFE OPERATION

- Become familiar with the operation of this product.
- Keep operating area clear of all persons and pets. Do not touch when in use (the hot metal can burn).
- Keep children away from the product at all times.
- Keep all wood inside the Bonfireball when in use.
- Never attempt to use the Bonfireball to support other objects.
- Do not operate with missing, broken, or unauthorized parts.
- Never climb or stand on the Bonfireball, it was not designed to hold your weight.
- Always check local ordinances to be sure a fire is allowed in your area before using this product.

## Parts

After unpacking, inspect parts carefully. If a part is missing or damaged, contact us directly at (810) 686-8252.

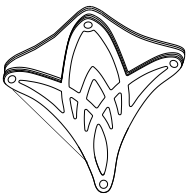

Combo Stack (5)

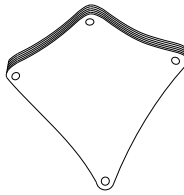

Base Stack (1)



Nut  
(70)



Kite Stack (5)



Nut Wrench  
(1)

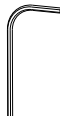

Hex Wrench  
(1)

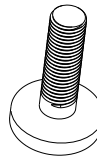

Bolt  
(70)



Base Wall  
(5)

# Using Bolts

**Bolt heads must always face outside the fire pit during assembly.**

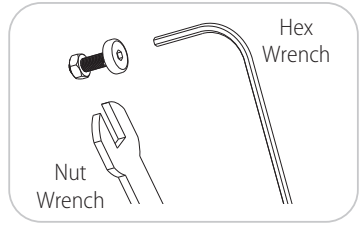
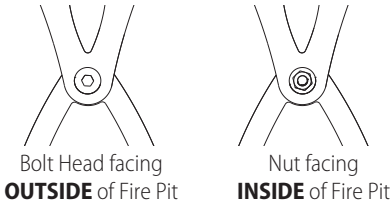

## Key Points to Remember Before you Begin

**Each tip must be connected in a specific way.**

"4...3...4"



Remember this Golden Rule!



**DO NOT TIGHTEN**

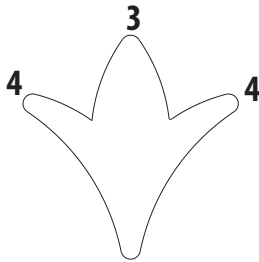
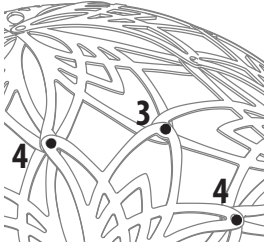

### Key

- 4 = Pointed Side tips have 4 connection layers.
- 3 = Round Center tips have 3 connections layers.

**NOTE:** Connect adjacent Face Layers with adjacent Face Layers (upper with upper and lower with lower).

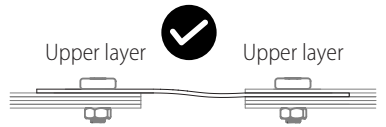
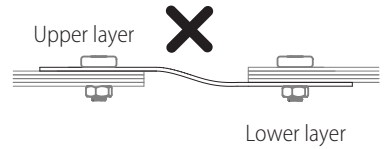

This will make for a smoother sphere shape when assembled.

## Assembly

**Each Kite tip must be connected in a specific way.**

Spread each of the **STACKS** open to prepare them for assembly as shown.

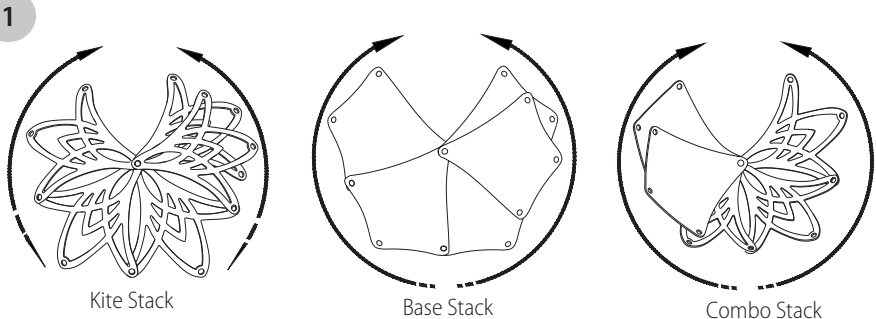

- 2 Expand the **BASE STACK** and assemble the **COMBO STACK** shown to form the Base of the Bonfireball .



**NOTE:**  
As you assemble, insert nuts and bolts but **DO NOT TIGHTEN** until all stacks have been attached.

First Combo Stack

Second Combo Stack

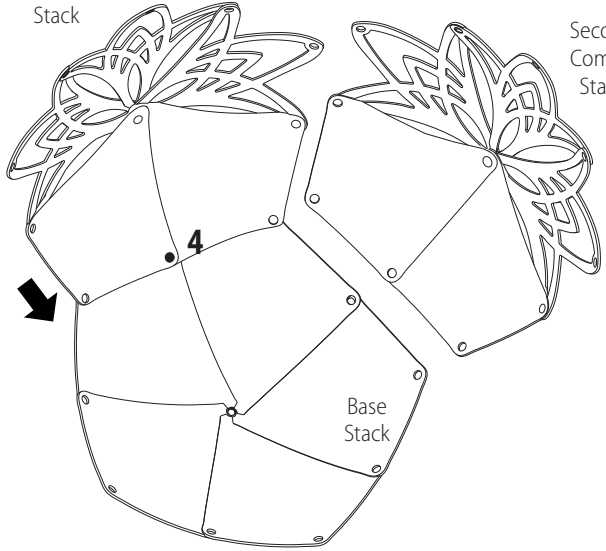

3

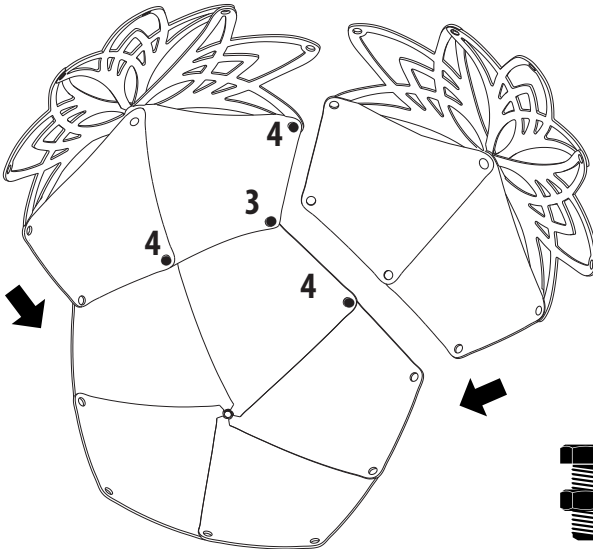

"4...3...4"



4

Continue connecting **COMBO STACKS** to **SECOND KITE STACK** with **BOLTS** as shown.

First Combo Stack



"4...3...4" **NOTE:**



As you begin to connect the Kite Stacks together, notice the **TIP PATTERN** that emerges.

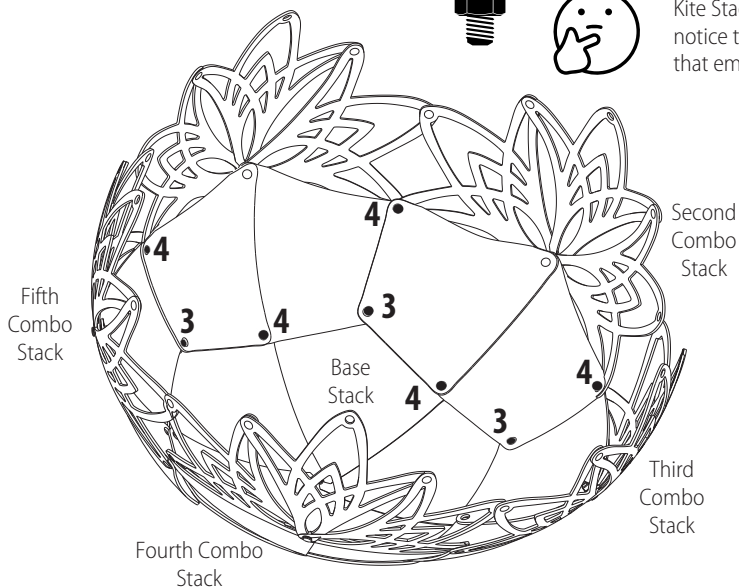

5

Install the remaining **KITE STACKS** around the Bonfireball in another layer.

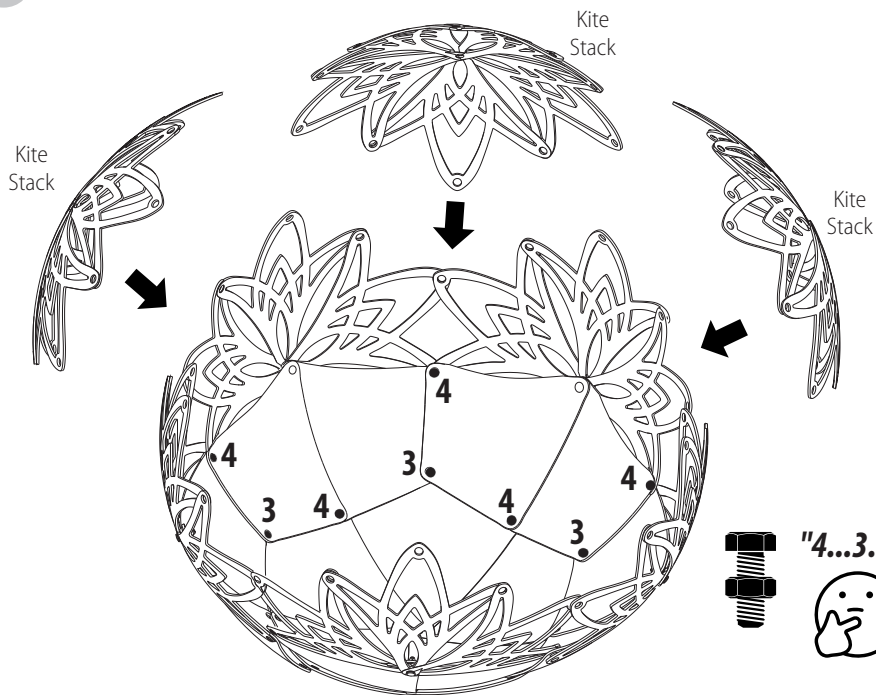

- 6 Continue to connect the **KITE STACKS** together and pay attention to the number of connections as shown in this top view.

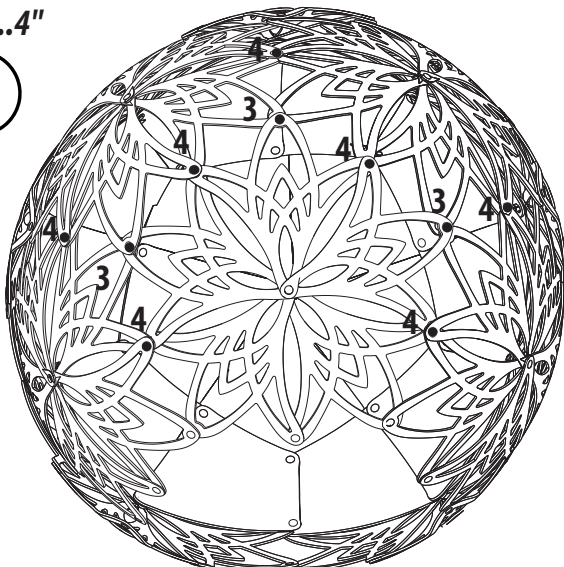

TOP VIEW

- 7 Continue to connect the **KITE STACKS** together, leaving an opening on one side of the Bonfireball (this opening allow logs to be inserted inside).

- 8 **TIGHTEN ALL BOLTS**  
on the Bonfireball.



FRONT VIEW

- 9 Assemble the **BASE WALLS** into a pentagon shape using the Nuts and Bolts.

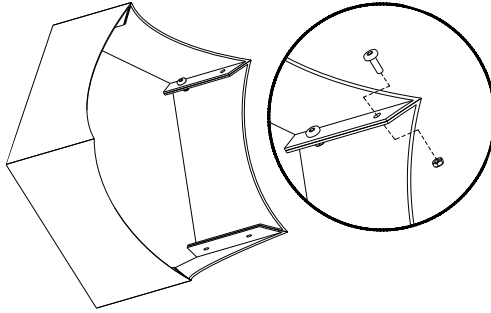

- 10 Place the sphere portion to the base.

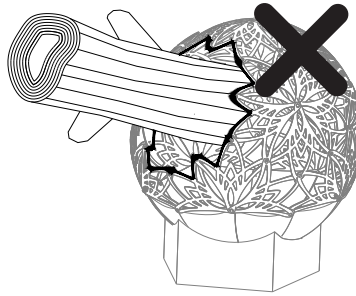
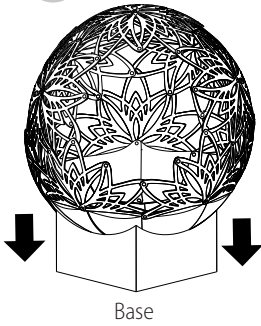

**NOTE:**  
Insert wood completely inside the Bonfireball. **DO NOT HANG WOOD OUT OF THE OPENING.**



Never touch the Bonfireball when in use, it can burn.

## Warranty

For refunds or if a part is missing or damaged, contact us directly at (810) 686-8252 for support.

## Maintenance

Occasionally inspect the Nuts and Bolts and tighten if necessary. Clean the Bonfireball with warm soapy water when cool.

## Disclaimer

This manual relates solely and exclusively to Bonfireball including but not limited to the operation thereof. Failure to adhere to this manual or to properly focus on the operation of the Bonfireball can result in serious injury and even death. Always operate the Bonfireball in a safe manner and in full compliance with this manual. Bonfireball is not liable for any injuries or damages to any operators, property, or bystanders incurred as a result of using this product. Bonfireball cannot be held liable for any and all errors in this manual or for any incidental or consequential damages that result from the use of the material presented in this manual. This manual contains proprietary information. All rights are reserved. No part of this manual may be photocopied, reproduced or translated to another language without the written consent.

P.O. Box 595  
Clio, MI 48420  
Phone: (810) 686-8252  
Fax: (810) 686-5492